

# TOTAL

One-Stop Tools Station

TOTAL

**INDUSTRIAL**  
**INVERTER**  
**GASOLINE**  
**GENERATOR**

**PRODUCT MANUAL**

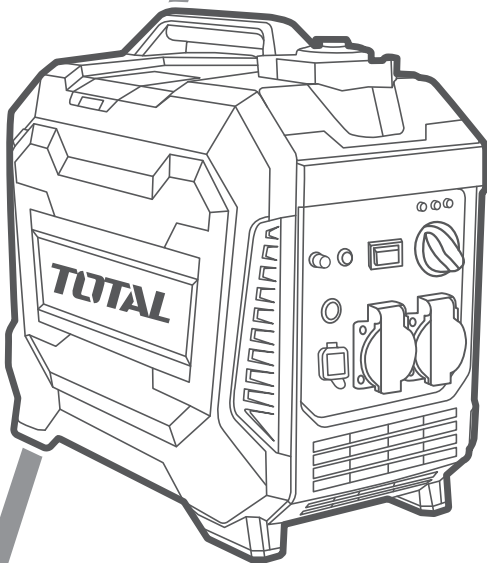

**TP535006 UTP535006**  
**TP535006x UTP535006x**  
**x(-4,-5,-6,-8,-9,S)**



## GENERAL SAFETY WARNINGS

The words DANGER, WARNING, CAUTION and NOTICE are used throughout this manual to highlight important information. Be certain that the meanings of these alerts are known to all who work on or near the equipment.

### WARNING

This safety alert symbol appears with most safety statements. It means attention, become alert, your safety is involved! Please read and abide by the message that follows the safety alerts symbol.

### DANGER

Indicates a hazardous situation which, if not avoided, will result in death or serious injury.

### WARNING

Indicates a hazardous situation which, if not avoided, could result in death or serious injury.

### CAUTION

Indicates a hazardous situation which, if not avoided, could result in minor or moderate injury.

### NOTICE









Indicates a situation which can cause damage to the generator, Personal property and/or the environment, or cause the equipment to operate improperly.





### NOTICE

Indicates a procedure, practice or condition that should be followed in order for the generator to function in the manner intended.

## THE SYMBOLS IN INSTRUCTION MANUAL

Some of following symbols are used in the machine or the manual. To understand their meanings will make it easy and safe for you in operation.

Symbol	Meaning
	Safety alert symbol
	Asphyxiation hazard
	Burn hazard
	Burst/pressure hazard
	Don't leave tools in the area
	Electrical shock hazard
	Explosion hazard
	Fire hazard
	Lifting hazard

	Pinch-point hazard
	Read manufacturer's instructions
	Read safety messages before proceeding
	Wear personal protective equipment (ppe)

**ADDITIONAL SAFETY WARNING****⚠ DANGER**

Never use the inverter in a location that is wet or damp. Never expose the inverter to rain, snow, water spray or standing water while in use. Protect the inverter from all hazardous weather conditions. Moisture or ice can cause a short circuit or other malfunction in the electrical circuit.



Never operate the inverter in an enclosed area. Engine exhaust contains carbon monoxide. Only operate the inverter outside and away from windows, doors and vents.

**⚠ WARNING**

Voltage produced by the inverter could result in death or serious injury.

- Never operate the inverter in rain or a flood plain unless proper precautions are taken to avoid being subject to rain or a flood.
- Never use worn or damaged extension cords.
- Always have a licensed electrician connect the inverter to the utility circuit.
- Never touch an operating inverter if the inverter is wet or if you have wet hands.
- Never operate the inverter in highly conductive areas such as around metal decking or steel works.
- Always use grounded extension cords. Always use three-wire or double-insulated power tools.
- Never touch live terminals or bare wires while the inverter is operating.
- Be sure the inverter is properly grounded before operating.

**⚠ WARNING**

Gasoline and gasoline vapors are extremely flammable and explosive under certain conditions.



- Always refuel the generator outdoors, in a well-ventilated area.
- Never remove the fuel cap with the engine running.

- Never refuel the inverter while the engine is running. Always turn engine off and allow the generator to cool before refueling.
- Only fill fuel tank with gasoline.
- Keep sparks, open flames or other form of ignition (such as match, cigarette, static electric source) away when refueling.
- Never overfill the fuel tank. Leave room for fuel to expand. Overfilling the fuel tank can result in a sudden overflow of gasoline and result in spilled gasoline coming in contact with HOT surfaces. Spilled fuel can ignite. If fuel is spilled on the inverter, wipe up any spills immediately. Dispose of rag properly. Allow area of spilled fuel to dry before operating the inverter.
- Wear eye protection while refueling.
- Never use gasoline as a cleaning agent.
- Store any containers containing gasoline in a well-ventilated area, away from any combustibles or source of ignition.
- Check for fuel leaks after refueling. Never operate the engine if a fuel leak is discovered.

 **WARNING**



Never operate the inverter if powered items overheat, electrical output drops, there is sparking, flames or smoke coming from the inverter, or if the receptacles are damaged.



Never use the inverter to power medical support equipment.



Always remove any tools or other service equipment used during maintenance from the inverter before operating.

 **NOTICE**

Never modify the inverter.

Never operate the inverter if it vibrates at high levels, if engine speed changes greatly or if the engine misfires often.

Always disconnect tools or appliances from the inverter before starting.

## SPECIFICATIONS

Thank you for purchasing this superior quality portable generator. When operating and maintaining this product as instructed in this manual, your generator will give you many years of reliable service.

### **Technical specifications**

This generator is an engine-driven, revolving field, alternating current (AC) portable generator. It is designed to supply electrical power to operate tools, appliances, camping equipment, lighting, or serve as a backup power source during power outages.

Model	TP535006,TP535006-4 TP535006-6,TP535006-8 TP535006-9,TP535006S	TP535006-5	UTP535006
Voltage	220-240V~	220-240V~	110-120V~
Frequency	50Hz	60Hz	60Hz
Power(COP)	3.0kW		
Power (Max.)	3.2kW		
Rated current	13A	13A	26A
DC Outlet	12V/8A		
Engine type	4 Stroke/ Single cylinder/ OHV		
Displacement	140cc		
Fuel tank capacity	6.3L		
Engine Oil Capacity	0.4L		
Starting Type	Recoil start		

The rated power output of the generator, the following standard reference conditions shall be used

Total barometric pressure: 100kPa

Air ambient temperature: 298K (25°C)

Relative humidity: 30%

Altitude: 0m

## OPERATION PICTURE

Control Panel Spark Plug Cover Recoil Starter

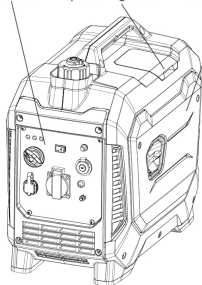

Oil Maintenance Cover Handle Air Vent Fuel cap

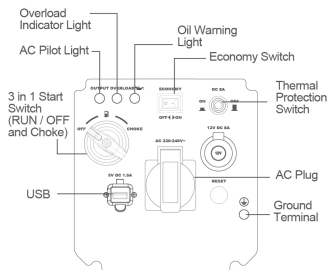
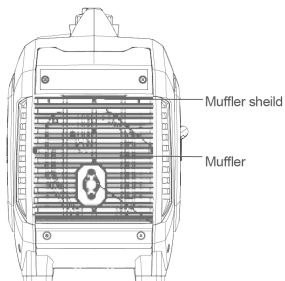
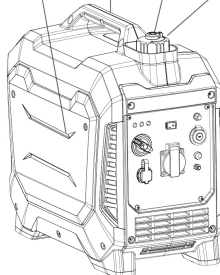

## OPERATION

### ON/OFF start switch and choke

Start switch "OFF"

When the start switch is in the "OFF" position the fuel valve is switched off and the engine will not run.

Start switch "CHOKE"

When the start switch is in the "CHOKE" position the fuel valve is switched on and the engine can be started

Start switch "ON"

When the start switch is in the "ON" position the fuel valve is switched on and the engine can run.

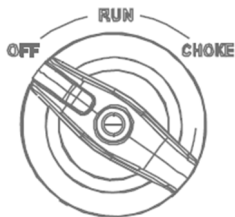

### Oil warning indicator light

When the oil falls below the minimum level, the oil warning indicator light comes on and the engine stops automatically.

The engine will not

#### Note:

If the oil warning indicator light does not come on and the engine stalls, turn the start switch to "ON" and pull the recoil starter.



### Engine overload indicator light

If the engine overload indicator light comes on, the generator's wattage / Amperage capacity has been exceeded by connected electrical devices or by a power surge. When this occurs, the green AC Pilot Indicator Light will go off. The engine will continue to run, but the red engine overload indicator light will stay on and power will no longer be supplied to connected electronic devices.

## How to correct

1. Disconnect any electronic devices then stop the engine.
2. Reduce the total wattage of connected electronic devices until it is within the generator's rated output.
3. Inspect the air inlet and control panel for any blockage. Remove blockage if found.
4. Restart engine.

### Note:

The engine overload indicator light may turn on for a few seconds when attaching a load due to a power surge. This is normal.

## Control panel functions

### AC pilot indicator light

The green AC pilot indicator light comes on when the engine starts and generates power.

### DC circuit breaker

When the DC circuit breaker is in the "ON" position, the generator is able to supply power to connected electronic devices. When the DC circuit breaker is in the "OFF" position, the generator will no longer supply power. The DC circuit breaker automatically turns "OFF" when connecting electronic devices to the generator that exceed the generator's rated output. If the DC circuit breaker turns off, reduce the load of connected electronic devices until the load is within the specified rated output. To re-establish power, return the DC circuit breaker back to the "ON" position.

## CAUTION

**If the DC circuit breaker turns off again, stop using the generator immediately and consult our dealers.**

## Engine ECO control

- When the engine ECO switch is turned to the "ON" position, the economy control unit automatically determines the generator's proper engine speed based on the connected electronic load. This results in superior fuel economy and reduces noise.
- When the ECO switch is turned to the "OFF" position, the engine runs at the rated speed of 4,800 r/min.

**⚠ NOTE**

The ECO switch must be turned to the “OFF” position when using electronic devices that require a large starting current, such as a compressor.

**Fuel cap**

Turn counterclockwise to remove the fuel cap

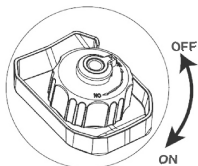
**Ground terminal**

The generator's ground terminal must always be used to connect the generator to a driven ground rod. Connect the ground terminal to the driven ground rod with a No 8 AWG (American Wire Gage) copper wire. The wire connects to the terminal between the lock washer and nut.

Tighten the nut securely to ensure good connection. Grounding the generator protects you from electric shock that results from a buildup of static electricity or undetected ground faults.

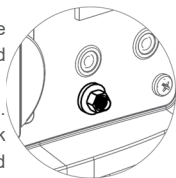
**⚠ WARNING**

**Generator must be properly grounded to prevent electrocution.**

- Only operate generator on a level surface.
- Always connect the nut and ground terminal on the frame to an appropriate ground source.

## Assembly

### Connecting generator to an electrical system

- If connecting generator to a building's electrical system for standby power, you must use a qualified electrician to install a transfer switch. The power from the generator must be isolated from the circuit breaker or alternative
- Never directly connect generator to a household power source.

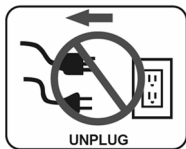

### **⚠** WARNING



**This generator produces a very high voltage which could result in burn or electrocution causing serious injury or death.**

- Never handle the generator, electronic devices, or any cord while standing in water, while barefoot, or when hands or feet are wet.
- Always keep the generator dry. Never operate generator in rain or under wet conditions.
- Never plug electronic devices into generator having frayed, worn, or bare wires. Never touch bare wires or make contact with receptacles.
- Never permit a child or unqualified person to operate generator. Keep children a minimum of 10 feet away from the generator at all times.
- If using the generator for backup power, notify the utility company.
- If connecting generator to a building's electrical system for standby power, you must use a qualified electrician to install a transfer switch. Failure to isolate the generator from the power utility could result in serious injury or death to electric utility works.
- When using extension lines or mobile distribution networks the total length of lines for a cross section of 1.5 mm<sup>2</sup> should not exceed 60 m; for a cross section of 2.5 mm<sup>2</sup> this should not exceed 100 m.
- The generating set must not be connected to other power sources except with accessory advised by the manufacturer or other generators with the same model.
- Save these instructions. Refer to them frequently and use them to instruct others who may use this product. If you loan someone this product, loan these

instructions also.

- Due to high mechanical stresses, only tough rubber sheathed flexible cable (in accordance with IEC60245-4) or the equivalent should be used.

### Adding fuel

- Set generator on a clean and level surface in an area that is well ventilated.
- Remove fuel cap.
- Insert a funnel into the fuel tank and carefully pour gasoline into the tank until fuel level reaches about 1 ½ inches below the top of the neck. Be careful not to overfill the tank to provide space for fuel expansion.
- Replace fuel cap and secure tightly.

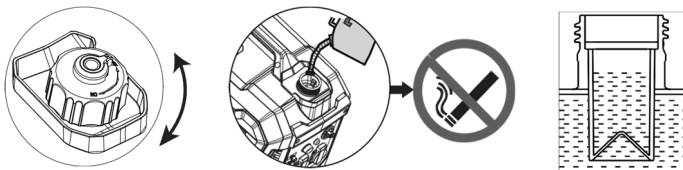

Do not smoke when adding fuel.

Do not to overfill the tank to provide space for fuel expansion.

### Adding / checking engine oil

- Place the generator on a solid, flat, level surface.
- On the right side of the generator, loosen the screws and remove the maintenance cover.

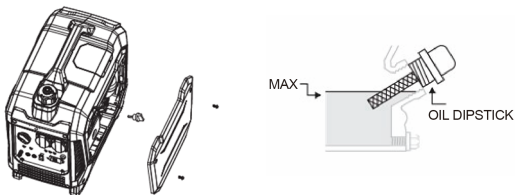

- Remove oil fill cap/dipstick to add oil.
- Using a funnel, as needed, add the appropriate type of oil until the oil level is

at the proper level. SAE 10w-30 oil is recommended for general use. DO NOT OVERFILL. Replace oil fill cap/dipstick and secure maintenance cover.

- Check engine oil level daily and add as needed.

**Recommended oil:** SAE 10W-30

**Oil capacity:** 0.35L

### CAUTION

**Generator has been shipped without engine oil. You must add oil before first operating this generator. Always check oil level before each operation.**

### **Grounding the generator**

To avoid electrocution, this generator must be properly grounded prior to use. For instructions see control panel functions pg.

### **Standard atmospheric conditions**

Ambient temperature: 77°F (25°C)

Barometric pressure: 100kPa

Relative humidity: 30%

Generator output will vary due to changes in temperature, altitude, and humidity. If the temperature, humidity, or altitude are higher than standard atmospheric conditions, the generator's output will be reduced. The load attached to the generator must therefore be reduced.

### **How to start engine**

- Make sure the generator is on a solid, flat, level surface.
- Disconnect all electrical loads from the generator. Never start or stop the generator with electrical devices plugged in or turned on.
- Turn the vent knob ON the tank cap to ON
- Turn 3in1 switches to ON
- Switch OFF the Low Idle
- Turn the Battery Switch ON for electric start.

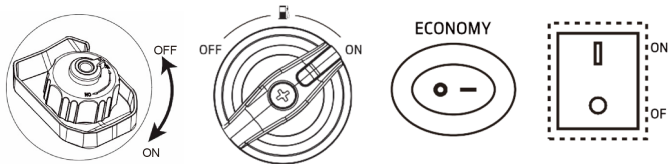

- For Recoil Start: Recoil Start: Firmly grasp and pull the recoil handle slowly until you feel resistance, let it retract then pull swiftly. If it fails to start successfully, wait for 3 seconds then repeat this step.
- Push Button Start: Press the start button once, the engine will ignite twice automatically. If it fails to start successfully, press the button again

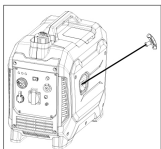

### **⚠ WARNING**

**Pull cord recoils rapidly and pulls arm towards engine faster than you can let go which could result in injury.**

- To avoid recoil, pull starter cord slowly until resistance is felt, then pull rapidly.

### **⚠ NOTE**

**To start the generator with the ECO switch in the “ON” position**

- Disconnect all electrical loads from generator.
- If ambient temperature is below 32°F (0°C) allow 3 minutes for the engine to warm up.
- The ECO is in “ON” position, the unit returns to normal operation after the above warm up time.
- ECO switch must be turned to the “OFF” position when using electronic devices that require a large starting current, such as a compressor.

## How to stop engine

- Turn the ECO switch to the “OFF” position
- Disconnect any electronic device. All loads MUST be disconnect from the generator. Never start or stop the engine with electrical devices plugged in to the receptacles.
- Turn the 3 in 1 start switch to the “OFF” position.
- Turn the air vent to the “OFF” position.

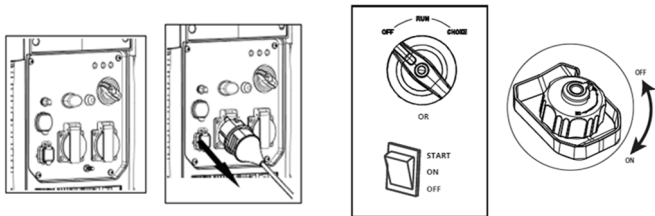

## ⚠ WARNING

**Never start or stop engine with electrical devices plugged in to the receptacles. Failure to do so could damage the generator and / or connected electrical devices.**

- Always start the engine and let it stabilize before connecting any electronic devices.
- Disconnect all electronic devices before stopping the engine.

## How to attach electronic devices

1. Before starting generator
  - Make sure the generator is grounded (see relevant page for instructions).
  - Make sure the attached load is within the generator rated output and the receptacle's rated current.
  - Make sure all electrical cords and receptacles are in good condition.
  - Make sure all electronic devices are turned “OFF” before plugging them into the generator.
2. Start engine
3. If the attached load is small, turn the ECO switch to the “ON” position. For a

larger load, or if attaching multiple electronic devices turn the ECO switch to the “OFF” position.

4. Make sure the green AC pilot indicator light is on.
5. When engine has stabilized, plug in and turn on first load, it is strongly recommended to plug in devices with the largest. Output first and the smallest output last to help prevent overloading the generator.
6. Allow generator output to stabilize (engine and attached devices run evenly) before plugging in the next load.

### **Don't overload generator**

Make sure you can supply enough rated watts for all electronic devices connected to the generator. Rated watts refer to the power a generator must supply to keep a device running. Surge watts refer to the power a generator must supply to start an electronic device. This power surge for starting a device usually lasts between 2-3 seconds but this additional output must be taken into account when selecting the electronic devices you plan to attach to the generator. To prevent overloading the generator take the following steps:

1. Add up the total rated wattage of all electronic devices that will be connected to the generator simultaneously.
2. Estimate surge watts by adding the item(s) with the highest output (it is unnecessary to calculate the surge output for all devices as they should be connected one at a time).
3. Add the surge watts to the total rated watts in step 1. Keep total load within generator's power capacity.

**Wattage reference guide**

(Wattages listed are just approximations. Check electronic device for actual wattage)

<b>Essentials</b>	<b>Rated Watts</b>	<b>Surge Watts</b>
75W light bulbs	75 each	75 each
18 CU Ft Refrigerator / Freezer	800	2200
Furnace fan (½ HP)	800	2350
Sump pump (½ HP)	1000	2000
Water pump (½ HP)	1000	3000
<b>Heating/Cooling</b>		
Dehumidifier	650	800
Table fan	800	2000
Electric blanket	400	400
Space heater	1800	1800
<b>Kitchen</b>		
Blender	300	900
Toaster (2 slice)	1000	1600
Coffee maker	1500	1500
Electric range (1 element)	1500	1500
Dishwasher	1500	3000
<b>Laundry room</b>		
Iron	1200	1200
Washing machine	1150	3400
Gas clothes dryer	700	2500

<b>Bathroom</b>	<b>Rated Watts</b>	<b>Surge Watts</b>
Hair dryer	1250	0
Curling iron	1500	0
<b>Family room</b>		
X-Box or play station	40	0
AM/FM Radio	100	100
VCR	100	100
Color TV (27")	500	500
<b>Home office</b>		
Fax machine	65	0
Personal computer (17" Monitor)	800	0
Laser printer	950	0
Copy machine	1600	0
<b>Power tools</b>		
1000w quartz halogen work light	1000	0
Airless sprayer (1/3 HP)	600	1200
Reciprocity saw	960	0
Circular saw (7 1/4")	1400	2300
Mitar saw (10")	1800	1800
Table/radial arm saw	2000	2000
Electric drill (1/2 HP, 5.4 Amps)	600	900

## MAINTENANCE&MALFUNCTIONS

Regular maintenance will extend the life of this generator and improve its performance. The warranty does not cover items that result from operator negligence, misuse, or abuse. To receive full value from the warranty, operator must maintain the generator as instructed in this manual, including proper storage.

### WARNING

**Before inspecting or servicing this machine, make sure the engine is off and no parts are moving. Disconnect the spark plug wire and move it away from the spark plug.**

### CAUTION

**If you are unsure of how to perform a maintenance task, have the unit serviced by our dealers.**

### CAUTION

**Only use our specified replacement parts.**

## Maintenance schedule

### Pre-operation steps

Before starting the engine, perform the following pre-operation steps:

- Check the level of the engine oil and the fuel tank level. Check for any leakage.
- Check fuel hose for cracks or damage. Replace if necessary.
- Make sure the air filter is clean.
- Remove any debris that has collected on the generator and around the muffler and controls. Use a vacuum cleaner to pick up loose debris. If dirt is caked on, use a soft bristle brush.
- Inspect the work area for hazards.

### After each use

Follow the following procedure after each use:

- Shut off engine.
- Store unit in a clean and dry area.

<b>After first 5 hours</b>	Change oil.
<b>After 8 hours or daily</b>	Clean debris.
	Check engine oil level.
<b>6 months (100 hr use)</b>	Check and clean air filter element. (serve more often under wet or dusty conditions.)
	Change engine oil. (serve more often under dirty or dusty conditions.)
	Check muffler screen. Replace if necessary
	Service spark plug.
	Inspect muffler and spark arrester
<b>12 months (300 hr use)</b>	Clean fuel filter. Replace if necessary.
	Check crankcase breather hose for cracks or damage. Replace if necessary.
	De-carbonize cylinder head. See dealer.
	Check and adjust valve clearance. See dealer.
	Check all fittings and fasteners. See dealer.

### Checking spark plug

- Remove cap. Then remove spark plug cap. Disconnect the spark plug wire from the spark plug.
- Before removing the spark plug, clean the area around its base to prevent debris from entering the engine.
- Insert a spark plug socket wrench through the opening on the outside of the cover. Turn the wrench counterclockwise.
- Check for discoloration and clean carbon deposits off the electrode with a wire brush.
- Check the electrode gap and slowly adjust to 0.7 - 0.8mm (0.028-0.031 in) if necessary.
- Reinstall spark plug and tighten to Torque 20.0Nm (14.8ft-lb).
- If spark plug is worn replace only with an equivalent replacement part. Spark plug should be replaced annually.
- Reconnect spark plug wire.

- Replace spark plug cap, then replace cap.

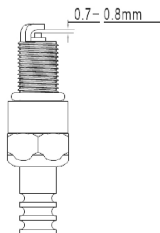

Standard spark plug: A5RTC

Spark plug gap: 0.7 - 0.8mm (0.028-0.031 in)

Spark plug torque: 20.0Nm (14.8ft-lb)

(Spark plug window)

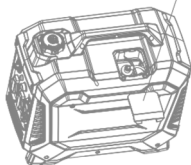

### Carburetor adjustment

The carburetor is low emission and is equipped with a non-adjustable idle mixture valve. If adjustment is needed contact an authorized dealer.

### Changing oil

- Make sure the engine is stopped and is level.
- On the right side of the generator, loosen the screws and remove the Oil Fill Access Door.
- Place an oil drain pan under the generator and center under the Oil Drain opening.
- Remove the oil drain plug from the generator, tilt the generator slightly to facilitate drainage, and wait for the oil to drain completely. Recycle used oil.
- Clean the top of the Oil Fill and the area around it.
- Add the appropriate type of oil until the oil level is at the proper level. SAE 10W-

30 oil is recommended for general use.

- Note: Make sure the generator is level when adding oil to prevent overfilling which could cause engine damage.
- Check the oil level. The oil level should be just below the edge of the hole as shown.
- Once you have filled your oil in the generator re-install the side panel.

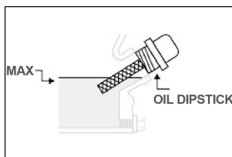
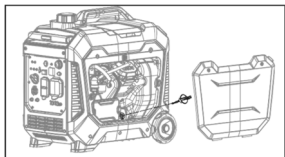

**Recommended engine oil:** SAE 10W-30

**Recommended engine oil grade:** API service SE type or higher quality of engine oil.

**Engine Oil Quantity:** 0.35L

#### **⚠ CAUTION**

**Do not tilt generator when adding oil. This could result in overfilling which could damage the engine.**

#### **⚠ CAUTION**

**Make sure no foreign matter enters the crankcase.**

#### **Air filter**

A dirty air filter will reduce the life span of the engine, make it difficult to start the engine. And reduce the unit's performance. Replace with new filter annually.

- To clean, remove the screws then remove outer casing.
- Remove the screws then remove air filter cover.
- Remove the foam element.
- Wash the foam element in solvent and let dry.
- Pour a small amount of oil on the foam element then squeeze out, but do not wring out, excess oil. Foam element should be damp, but not dripping.

- Reinsert the foam element into the air filter case.

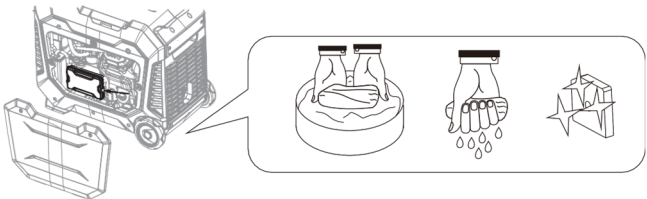

### **⚠ CAUTION**

**Do not run the generator without reinstalling the foam element or excessive piston and cylinder wear may result.**

### **Checking muffler and spark arrester**

Inspect muffler for cracks, corrosion, or other damage.

Loosen bolt, then remove muffler cap, muffler screen, and spark arrester.

Check the muffler screen and spark arrester for carbon deposits. Remove carbon deposits with a wire brush.

- Check the muffler screen and spark arrester for damage. If damaged replace with our replacement parts. Specifically designed for this unit.
- Install the spark arrester. Align the spark arrester projection with the hole in the muffler pipe.
- Install the muffler screen and muffler cap.

### **⚠ WARNING**



**Avoid contacting hot areas of this unit.**

- Use caution around the muffler, cylinder, and other engine parts as they can be extremely hot.
- Allow hot components to cool before touching.

### **Fuel tank filter**

- To clean, remove fuel cap and filter.

- Clean filter with gasoline.
- Wipe the filter with a clean rag.
- Install filter
- Install fuel cap.

### Fuel filter

- To clean, remove screws, remove outer casing, and drain fuel.
- Lift and hold onto the clamp, then remove hose from tank.
- Take out fuel filter
- Clean filter with gasoline.
- Wipe the filter with a clean rag and return filter to tank
- Install hose and clamp.
- Open fuel valve. Inspect for leakage.
- Install outer casing and tighten screws.

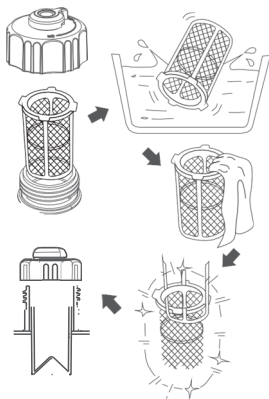

### Storage

To protect your generator from deterioration during long term storage, take the following preventative measures:

### Exterior

- Remove any debris that has collected on the generator and around the muffler and controls. Use a vacuum cleaner to
- pick up loose debris. If dirt is caked on, use a soft bristle brush.
- Inspect air cooling slots. Remove any debris if obstructed.
- Store indoors and use a protective cover to protect from dust.

### Fuel

- For short-term storage, add fuel stabilizer to prevent stale fuel from causing acid and gum deposits in the fuel system and carburetor.
- For long-term storage, drain the fuel.

## Engine

- Remove spark plug. Pour about 1 TBL of SAE 10W-30 engine oil into the spark plug hole, then reinstall spark plug.
- With the 3 in 1 switch in the “OFF” position, pull the recoil starter several times to coat cylinder walls with oil.
- Slowly pull the recoil starter until you feel the engine build compression (when you feel resistance). Leave the engine in this state. This will help prevent rust build up in the cylinder walls.

## How to drain fuel

- Turn the 3 in 1 switch to the “OFF” position.
- Remove fuel cap and fuel tank filter.
- Use a siphon to transfer gasoline from generator into a gasoline approved container.
- Wipe up any spilled fuel with a clean rag.
- Start generator engine and let it run until it stops and all remaining fuel is consumed. Do not connect electronic devices to generator during this process.
- Remove outer casing screws, then remove outer casing.
- Drain fuel from carburetor by loosening the drain screw on the carburetor float chamber.
- Turn the 3 in 1 switch to “OFF”
- Tighten the drain screw.
- Install the outer casing and tighten screws.
- When the engine has completely cooled down, turn the Fuel Cap Air Vent to the “OFF” position.

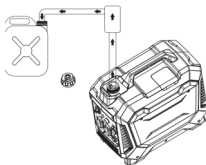
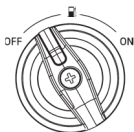

<b>Problem</b>	<b>Cause</b>	<b>Solution</b>
Generator is running, but does not supply power.	1. DC circuit breaker is "OFF"	1. Turn DC circuit breaker "ON"
	2. Green AC pilot light Indicator is off.	2. Stop engine and restart.
	3. Poor connection	3. Check and repair
	4. Defective cord set	4. Check and repair
	5. Connected device is faulty	5. Connect a device that is working properly
	6. Fault in generator	6. Contact service department
Engine runs good without load but bogs down when loads are connected	1. Short circuit in connected device	1. Disconnect device
	2. Generator is overloaded	2. See relevant pg "Don't overload generator"
	3. Clogged fuel filter	3. Clean or replace fuel filter
	4. Engine speed is too slow	4. Contact service department
	5. Short circuit in generator	5. Contact service department
Engine will not start, shuts down during operation, or starts and runs rough.	1. 3 in 1 switch set to "OFF"	1. Turn switch to "CHOKE" then pull recoil starter.
	2. Dirty Air filter	2. Clean or replace air filter
	3. Clogged fuel filter	3. Clean or replace fuel filter
	4. Out of fuel or stale fuel	4. Replace fuel
	5. Spark plug wire disconnected from spark plug	5. Reconnect spark plug wire
	6. Bad spark plug	6. Clean or replace spark plug
	7. Water in fuel	7. Drain fuel tank and replace fuel
	8. Over chocking	8. Turn off choke
	9. Low oil level	9. Add oil level.
	10. Engine has flooded	10. Wait 5 minutes and re-crank engine
	11. Faulty ignition	11. Contact our dealer
Engine lacks power	1. Generator is overloaded	1. See relevant pg, "Don't overload generator"
	2. Clogged fuel filter	2. Clean or replace fuel filter
	3. Dirty air filter	3. Replace air filter
	4. Engine needs servicing	4. Contact service department

Engine "hunts" or falters	1. Choke was removed too soon	1. Move to choke until engine runs evenly
	2. Clogged fuel filter	2. Clean or replace fuel filter
	3. Carburetor is running too rich or too lean	3. Contact service department

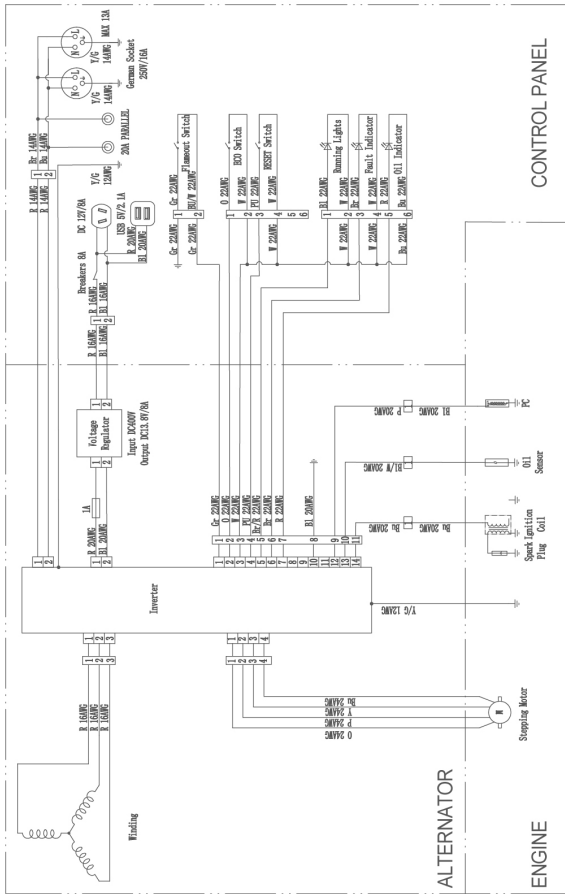

Bl	Black	Br	Brown	Gr	Yellow/Green
O	Orange	Wh	White	W/Y	Black/White
Bl	Blue	Bl	Black	P	Pink
Gr	Grey	W	White	Pu	Purple
R	Red	Y	Yellow	Brk	Brown/Red

# TOTAL

One-Stop Tools Station

[www.totalbusiness.com](http://www.totalbusiness.com)

   TOTAL TOOLS WORLD

MADE IN CHINA T0823.V01



NEWWAY TECHNOLOGY (SUZHOU) CO., LIMITED

No. 20 Dagang Road, Fuqiao Town, Taicang City, China

